

STEP

- SOFA MADE WITH COMPLETELY REMOVABLE COVER.
- SEAT & BACK SEAT CUSHIONS FILLED WITH GOOSE FEATHERS.
- PLASTIC LEDS -H=4 sm

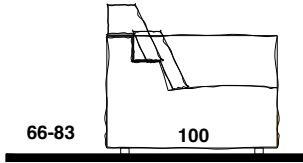

SOFA ELEMENTS



SIDE WIEW

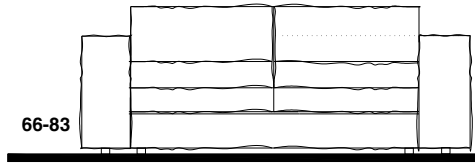

FRONT WIEW

3SEAT SOFA

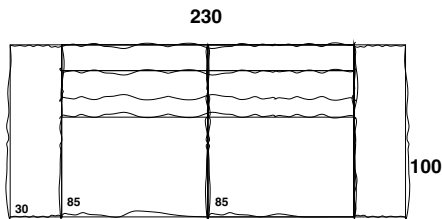

2 SEAT SOFA

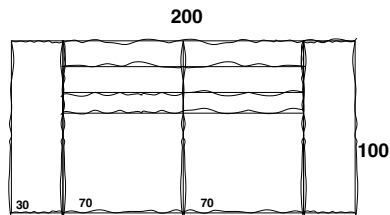

ANGLE 3 SEAT

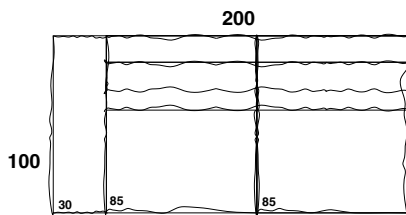

ANGLE 2 SEAT

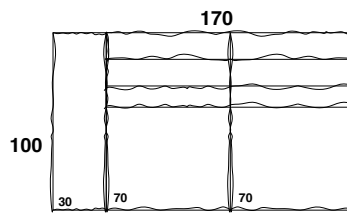

RELAX EL.
100

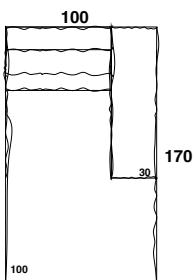

RELAX EL.
115

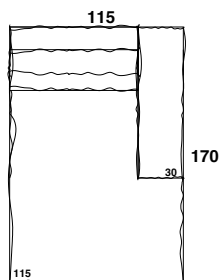

ANGLE EL.

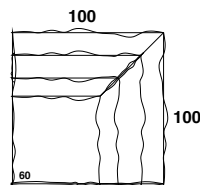

POUF

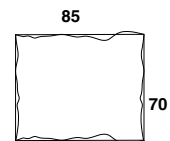

STEP

- SOFA MADE WITH COMPLETELY REMOVABLE COVER.
- SEAT & BACK SEAT CUSHIONS FILLED WITH GOOSE FEATHERS.
- PLASTIC LEDS -H=4 sm



SOFA ELEMENTS

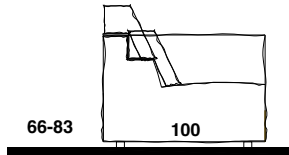

SIDE WIEW

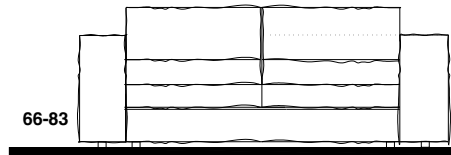

FRONT WIEW

ANGLE POSITIONS

ANG.3 SEAT+RELX 115

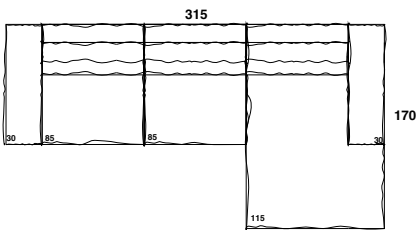

2ANGLE 3 SEATS
+ANGLE EL.

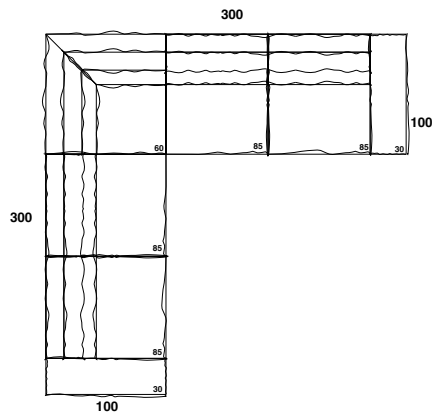

2 ANGLE 2 SEATS
+ANGLE EL.

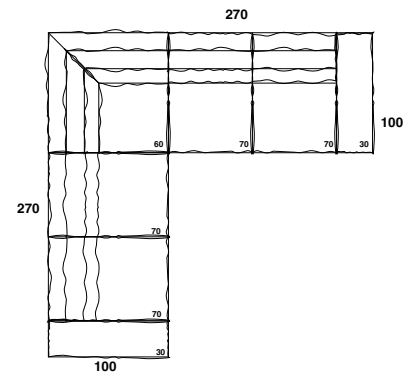

ANGLE 2 SEAT+RELX 100

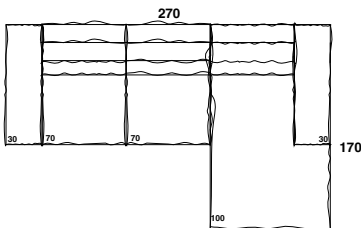

2ANG.3 SEATS
+ANG.EL.+RELX 115

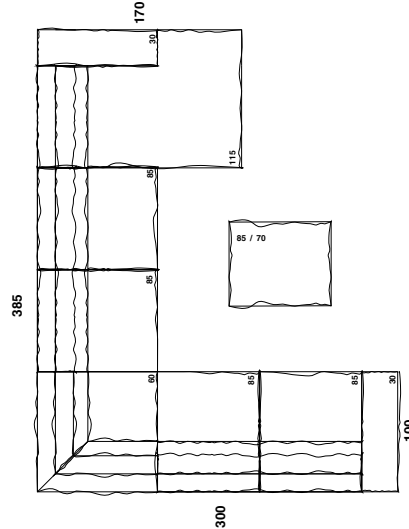

2 ANG.2 SEATS
+ANG.EL.+RELX100

