

# VARIETY

- POLYURETANE BACKREST 20kg/m<sup>3</sup>
- SEAT MADE OF WIRED CORE AND EXPANDED UNDEFOMABLE H.R POLYURETHANE 35kg/m<sup>3</sup>
- BACK CUSHIONS FILLED UP WITH GROUND POLYURETHANE AND SILICONE GRANULES
- METAL LEG SPK-80 H-15,5cm



\*\*\*NOTICE - ALLOWED UPHOLSTERED DIMENSION +/- 2 cm

## VIEW

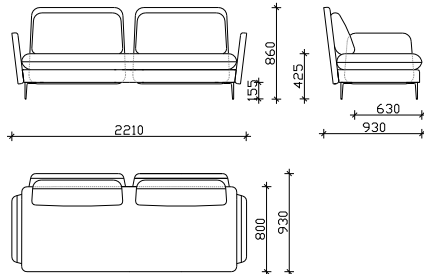

## SOFA ELEMENTS

2 SEATER

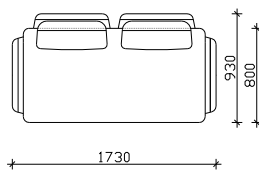

2/5 SEATER

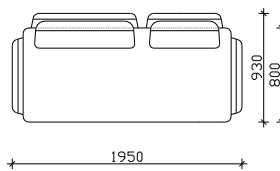

3 SEATER

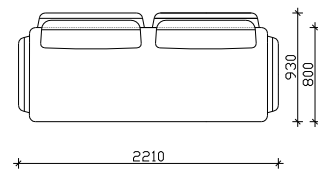

## ANGLE ELEMENTS

ANGLE 2 SEATER

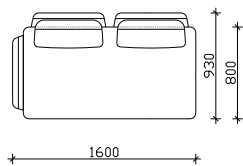

ANGLE 2/5 SEATER

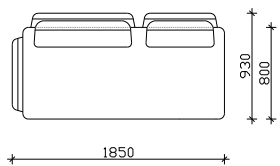

ANGLE 3 SEATER

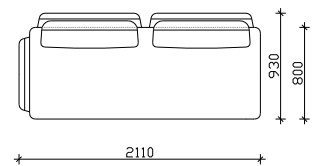

EXTENDED 3 SEATER 213cm

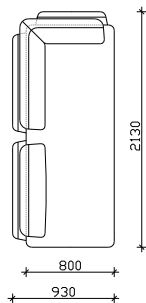

EXTENDED 3 SEATER 188cm

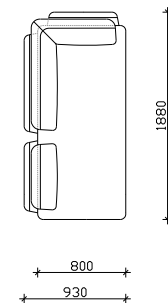

RELAX

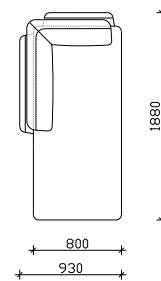

1 SEATER 100cm

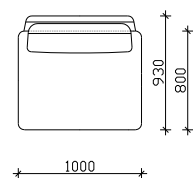

1 SEATER 75cm

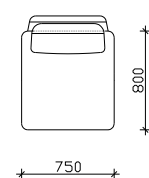

POUF

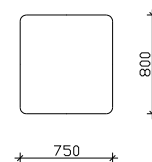

# VARIETY

- POLYURETANE BACKREST 20kg/m<sup>3</sup>
- SEAT MADE OF WIRED CORE AND EXPANDED UNDEFOMABLE H.R POLYURETHANE 35kg/m<sup>3</sup>
- BACK CUSHIONS FILLED UP WITH GROUND POLYURETHANE AND SILICONE GRANULES
- METAL LEG SPK-80 H-15,5cm



\*\*\*NOTICE - ALLOWED UPHOLSTERED DIMENSION +/- 2 cm

## COMBINATIONS

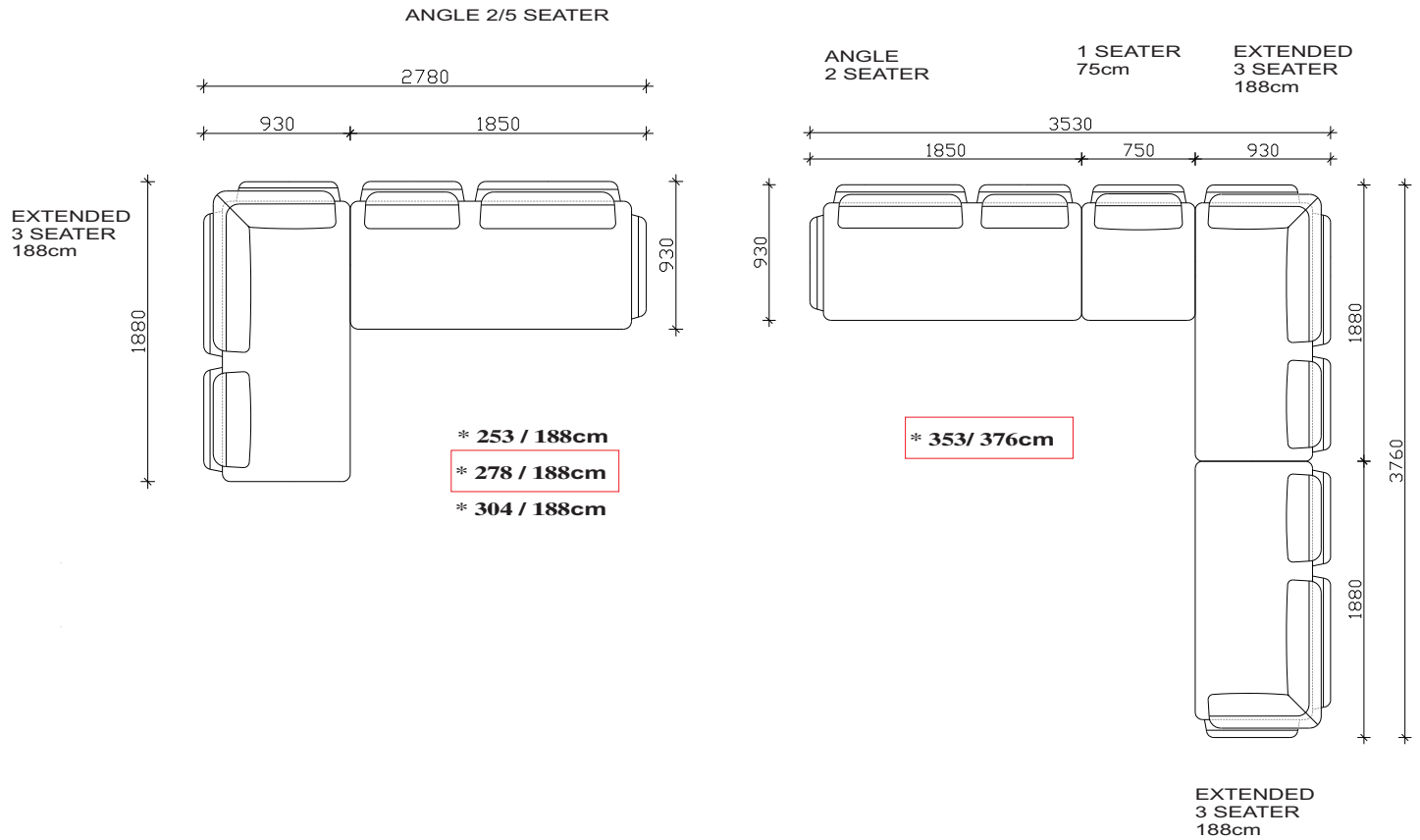

# VARIETY

- POLYURETANE BACKREST 20kg/m<sup>3</sup>
- SEAT MADE OF WIRED CORE AND EXPANDED UNDEFOMABLE H.R POLYURETHANE 35kg/m<sup>3</sup>
- BACK CUSHIONS FILLED UP WITH GROUND POLYURETHANE AND SILICONE GRANULES
- METAL LEG SPK-80 H-15,5cm

\*\*\*NOTICE - ALLOWED UPHOLSTERED DIMENSION +/- 2 cm



## VIEW

### SOFA BED

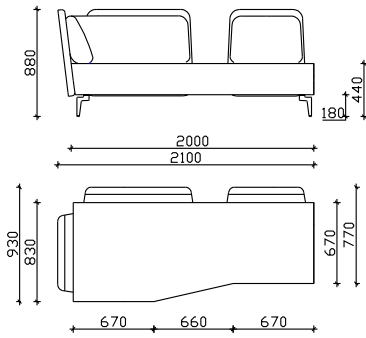

## COMBINATIONS

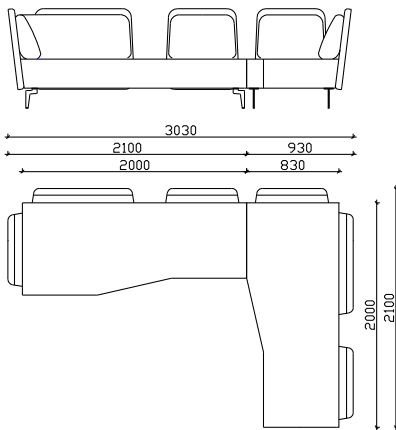

\* 303/ 210cm

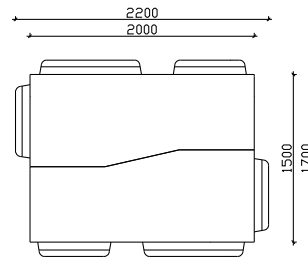

\* 220/ 170cm